

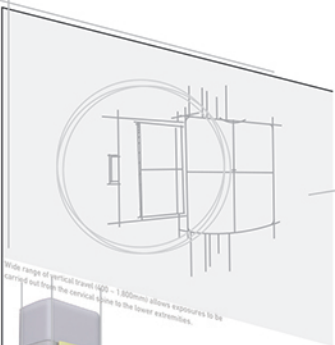

Clear Vision DRE series



Wide range of vertical travel (up to 130mm) allows exposures to be centred but from the closest close to the lower extremities.



... detector for digital radiographic applications delivers high resolution, low noise and superb image quality. Portable ... detector provides unlimited clinical applications.

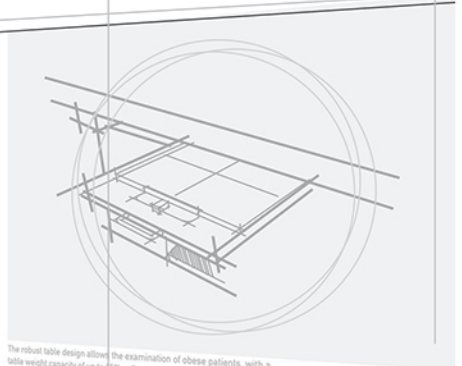

The robust table design allows the examination of obese patients, with a table weight capacity of up to 500kg. Due to the footswitch integrated into the table base the operator can care the patient safely without any unexpected movement of the tabletop.

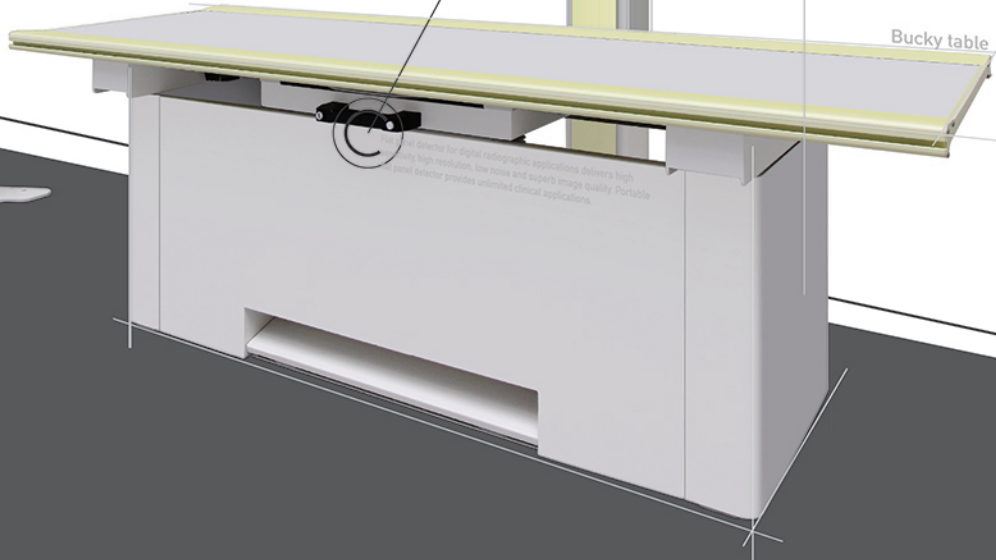

... detector for digital radiographic applications delivers high resolution, low noise and superb image quality. Portable ... detector provides unlimited clinical applications.

Economic Digital Radiography System

Clear Vision DRE140

Clear Vision DRE150

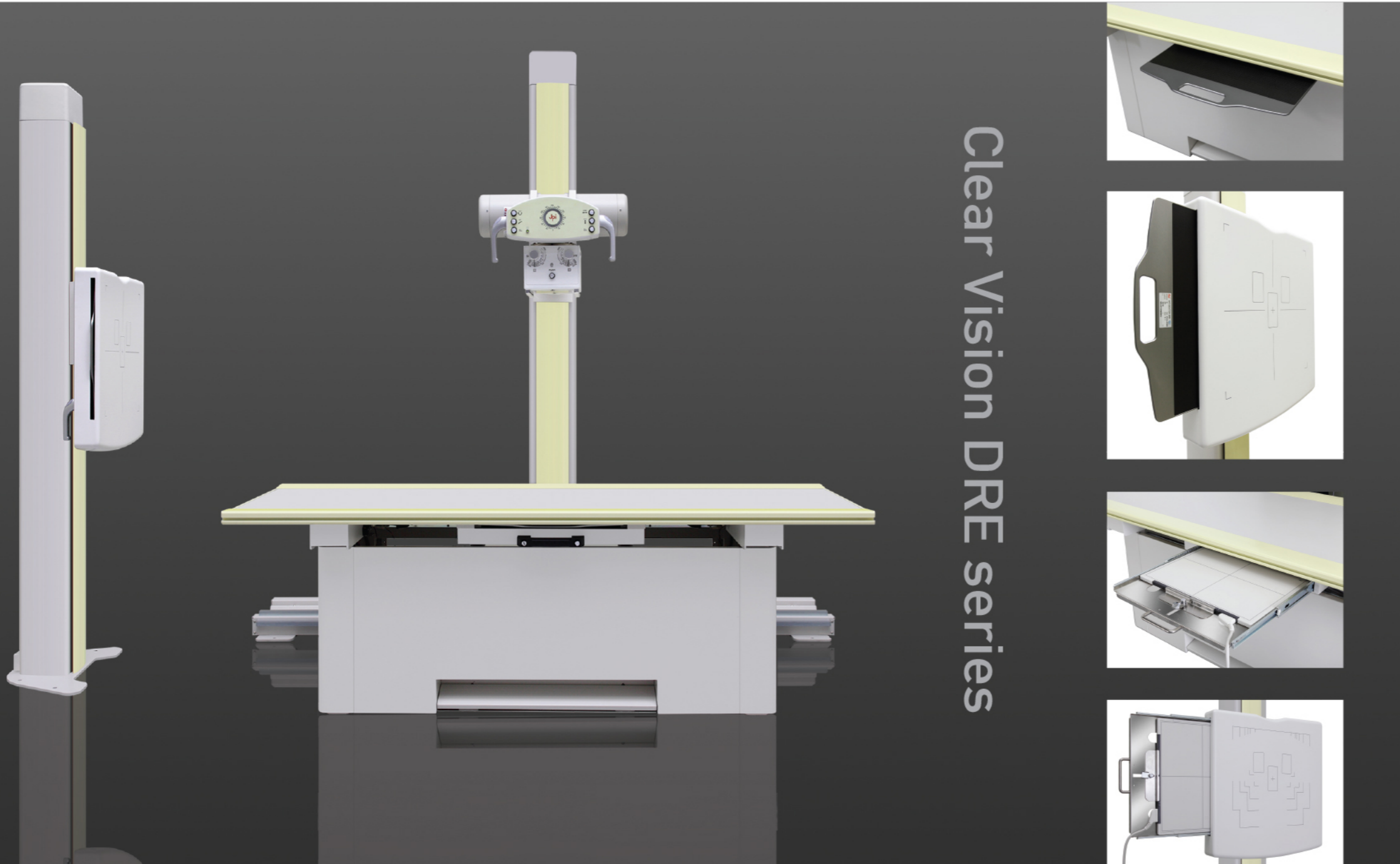

Clear Vision DRE series



Operation Software

ExamVue software presents a comprehensive set of X-ray image analysis tools through the use of a fast and easy-to-use interface. ExamVue offers high performance image processing and measurement functions.

X-ray Generator

High frequency generator ensures minimum patient dose, excellent reproducibility, and superior image contrast.

Flat panel detector

Flat panel detector for digital radiographic applications delivers high sensitivity, high resolution, low noise and superb image quality. Portable flat panel detector provides unlimited clinical applications.

Tube stand

Ergonomically designed tube stand provides the operator with faster and easier movement for table and stand examinations.

Bucky stand

Wide range of vertical travel (400 ~ 1,800mm) allows exposures to be carried out from the cervical spine to the lower extremities.

Bucky table

The robust table design allows the examination of obese patients, with a table weight capacity of up to 150kg. Due to the footswitch integrated into the table base the operator can care the patient safely without any unexpected movement of the tabletop.

Examvue Software

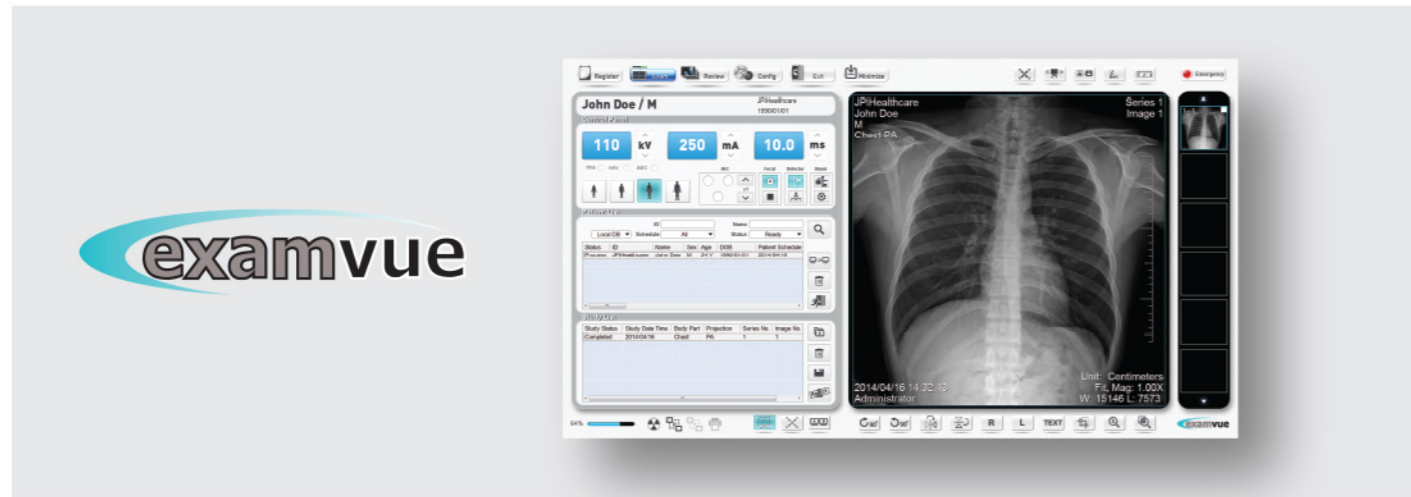

- Easy to use and learn
- Fully compatible with DICOM 3.0 standard
- Ability to convert and export images, archive to PACS
- Patient registration Worklist support
- Predefined and custom Image processing modes
- Optimized algorithms for each body part
- Standard Image manipulation tools such as :
Windows level, Zoom, Pan, Crop, Invert, Rotation
- Standard measure tools such as : Length, Angle
- Image labels and text annotations
- Image import/export
- CD/DVD burning
- Image Stitching
- Side to side multi-image comparison
- Auto collimation
- Image Reject and Merge

User Friendly Design

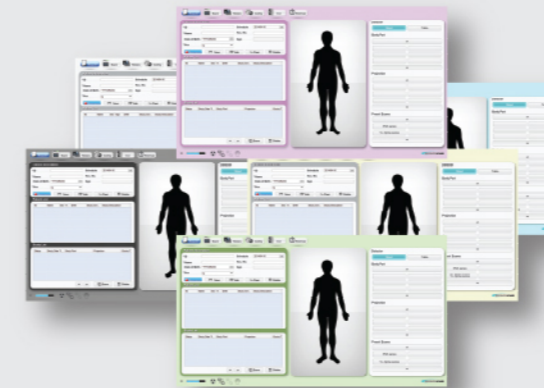

(Changeable Skin)

Simple & Fast Workflow



(Register mode)

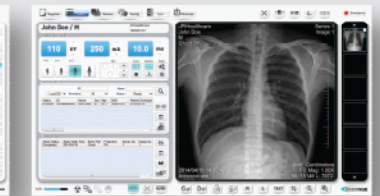

(Exam mode)



(Review mode)

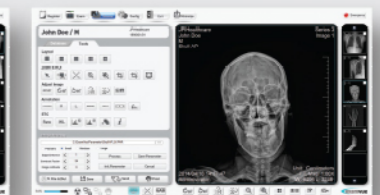

(Review mode)

Convenient Diagnosis Function



(Comparison)

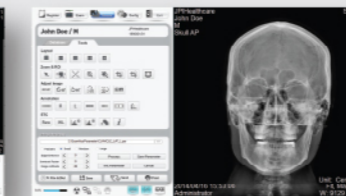

(Expand)



(Full Screen)

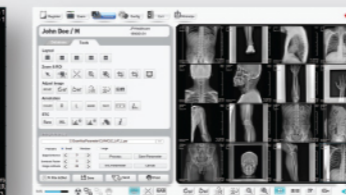

(Multiple View)

Multiple Monitor



(Unlimited Additional Monitor Connections)

Specifications of the system

Generator		
Max. Output	40kW	50kW
mA range	10 ~ 500mA	10 ~ 630mA
kV range	40 ~ 125kV	40 ~ 150kV
mAs range	0.1 ~ 630mAs	0.1 ~ 630mAs
Power supply	1Ø 220VAC 50/60Hz	3Ø 380VAC 50/60Hz
Exposure time	0.001 ~ 10sec	0.001 ~ 6.3sec
No. of APR	216	1,024
Option	AEC	AEC/ High speed rotor/ DAP/
Application	DRE140	DRE150



X-ray tube		
Focal spot	1.0/2.0mm	0.6/1.2mm
Anode heat capacity	100kJ (140kHU)	210kJ (300kHU)
Target angle	16°	12°
Voltage range	40 - 125kV	40 - 150kV
Weight	16kg	18kg
Permanent filtration	0.9mmAl	0.9mmAl
Application	DRE140	DRE150



Clear Vision DRE series

Flat panel detector		
Scintillator	CsI	CsI
Pixel pitch	143µm	143µm
Resolution	3.7lp/mm	3.7lp/mm
MTF	36% [2.0lp/mm, 70kVp, 1x1]	36% [2.0lp/mm, 70kVp, 1x1]
DQE	70%	70%
Active Area	43 x 43.9cm	35 x 43cm
Pixel matrix	3,008 x 3,072	2,448 x 2,984
AD conversion	14 bits	16 bits
Energy range	40 ~ 150kVp	40 ~ 150kVp
Power supply	1Ø 100 ~ 240VAC 50/60Hz	1Ø 100 ~ 240VAC 50/60Hz
Dimension	512 x 495 x 43mm	460 x 384 x 15mm
Weight	16kg	3kg
Application	DRE140/150	DRE140/150



Collimator	
Power supply	1Ø 24VAC 50/60Hz
Max. kVp shield	150kV
Max. field size	35 x 35cm at SID 65cm
Inherent filtration	1.2mmAl
Lamp luminosity	Over 160Lux
Lamp time	30sec
Field size control	Manual
Application	DRE140/150



Specifications of the system

Tube stand

Vertical travel distance	1,500mm
Transverse travel distance	260mm
Min. Tube height (from floor)	550mm
Max. Tube height (from floor)	2,050mm
Column rotation	±90°
Tube rotation	±180°
Longitudinal travel distance	2,400 ~ 3,000mm (floor ceiling fixed type) 1,500mm (floor fixed type)
Power supply	24VDC, 3A
Weight	200kg (with rails)
Application	DRE140/150



Bucky stand

Vertical travel distance	1,400mm
Min. Bucky height (from floor)	400mm
Max. Bucky height (from floor)	1,800mm
Power supply	1Ø 16 ~ 24VAC 50/60Hz
Weight	120kg
Application	DRE140/150

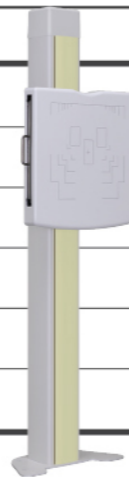

Bucky table

Table top size	2,000 x 745mm
Table top height	670mm
Table top material	Acryl
Longitudinal Travel distance	±280mm
Transverse travel distance	±140mm
Bucky travel distance	±230mm
Max. patient weight	Max. 150kg
Power supply	1Ø 220VAC 50/60Hz
Weight	160kg
Application	DRE140/150



PC & Monitor

PC OS	Windows 7 sp1
CPU	Intel i5 3.3GHz
RAM	4GB
HDD	1TB
Network	100/1000 Mbps or Fiber
CD R	CD/DVD RW
LCD Monitor size	23inch
Resolution	1,920 X 1,080
Application	DRE140/150



Types of system

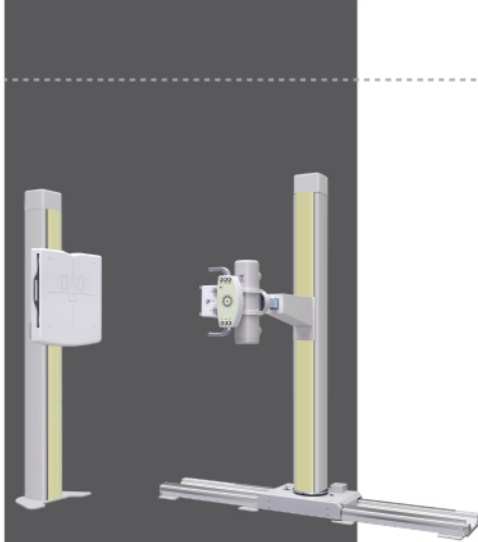

Clear Vision DRE 140/150
Bucky Stand + Tube Stand system
 Single Detector (14X17 or 17X17)

Configuration:
 Bucky stand, Tube stand(floor mounted or floor ceiling),
 Generator, PC&Monitor, Acquire software, Flat Panel Detector,
 Collimator

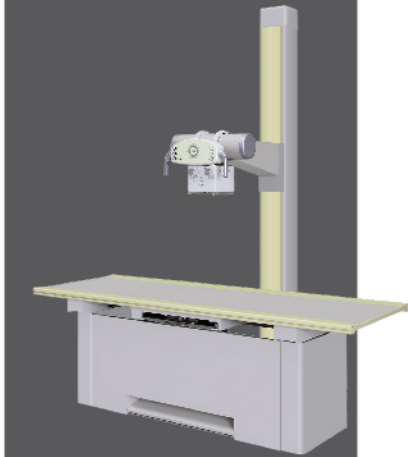

Clear Vision DRE 140/150
Tube Stand + Bucky Table(4way) system
 Single Detector (14X17 or 17X17)

Configuration:
 4Way Bucky table, Tube stand(floor mounted or floor ceiling),
 Generator, PC&Monitor, Acquire software, Flat Panel Detector,
 Collimator



Clear Vision DRE 140/150
Bucky Stand + Tube Stand + Bucky Table(4way) system
 Single Detector (14X17)
 Dual Detector (14X17 or 17X17)

Configuration:
 4Way Bucky table, Bucky stand, Tube stand(floor mounted or floor ceiling),
 Generator, PC&Monitor, Acquire software, Flat Panel Detector,
 Collimator

Configuration of the system

Components	DRE140 with fixed dual FPD	DRE140 with portable FPD (* with CR/film)	DRE150 with fixed dual FPD	DRE150 with portable FPD (* with CR/film)
40kW Generator	✓	✓ ✓	-	-
50kW Generator	-	-	✓	✓ ✓
17x17 Flat panel detector	✓	-	✓	-
14x17 Flat panel detector	-	✓	-	✓
150kV X-ray tube	-	-	✓	✓ ✓
125kV X-ray tube	✓	✓ ✓	-	-
Basic Configuration	* Tube stand, Bucky stand, Bucky table, PC & monitor, Acquisition Software			

* upgradable to floor mounted Tube stand
 * for international sales

Recommended Installation Room Layout

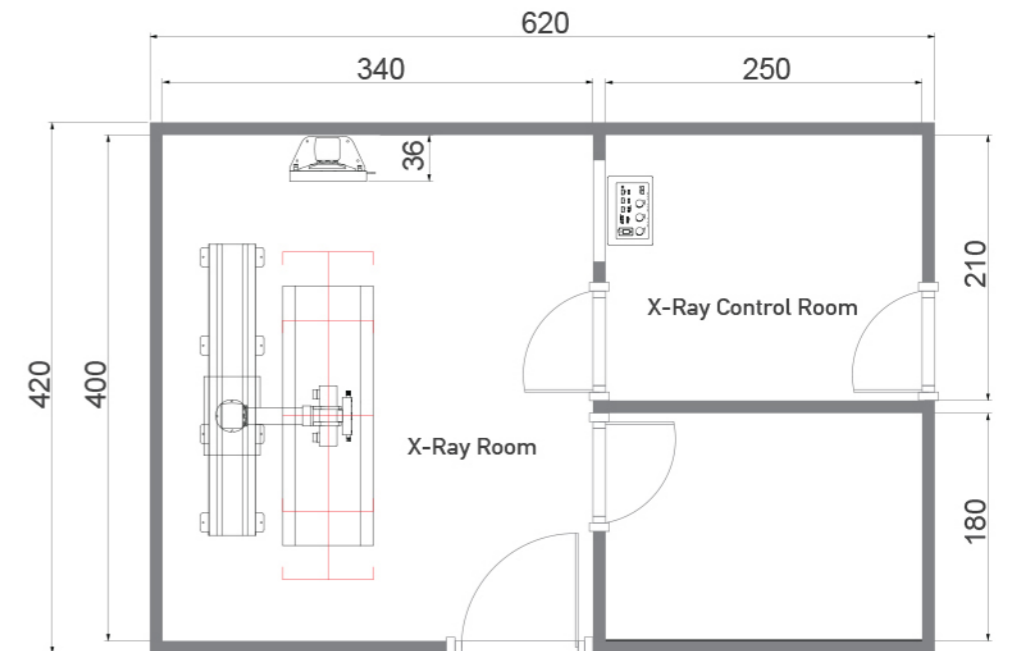

JPI Healthcare

Seoul -
#608, 28, Digital-ro 33-gil,
Guro-gu, Seoul, Korea 152-769
Tel : 82-2-2108-2580(Ext. 500~504)
Fax : 82-2-2108-1180
Web : www.jpi.co.kr / www.clearvision.co.kr

Ansan -
43, Seonggok-ro 22beon-gil,
Danwon-gu, Ansan-si,
Gyeonggi-do, Korea 425-833

Osong -
Osong-265, Osong saeng myeong 1-ro
Cheongwon-gun, Gungchungbuk-do,
Korea. 363-951



JSA-06-21[Ver 0.0]



TRANSBA MEDICAL SERVICES

 transba.net

 Transbabd.1



+88-01914-585662, +88-01972-115583

Service Hotline: +88-01911-176706



Head Office: 33 Topkhana Road, Meherba Plaza
Suite No. 15HJ, Dhaka-1000, Bangladesh.

Corporate Office: 33 Topkhana Road, Meherba Plaza
Suite No. 13KLMN, Dhaka-1000, Bangladesh.